

SCHWINGMETALL® Special Mounts

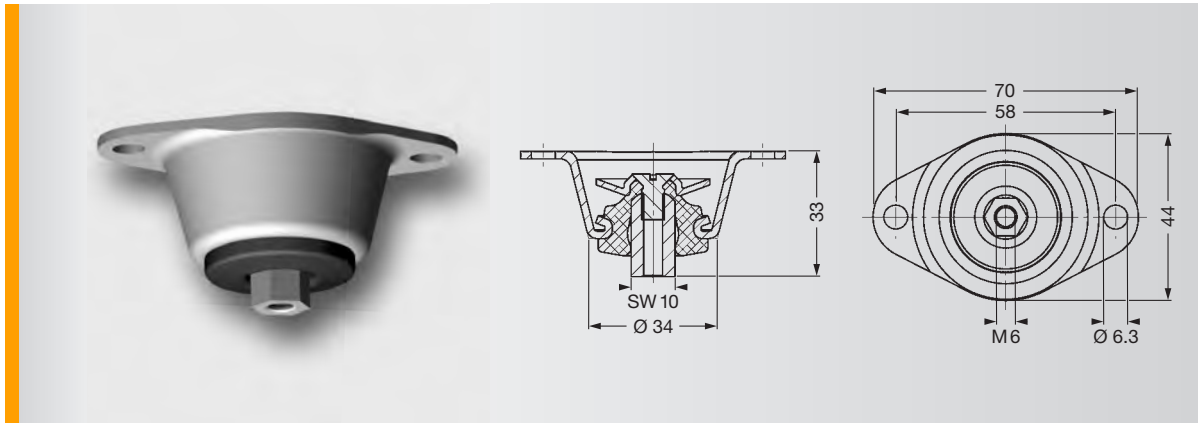

Bell Mounts 58500

Mould No.	Part No.	Spring Stiffness			Max. Loads			Mass Piece [kg]	Elas- tomer Hardness [Shore A]
		C_x [N/mm]	C_y [N/mm]	C_z [N/mm]	F_x [N]	F_y [N]	F_z [N]		
58500	3956408000	27	27	24	40	40	100	0.098	40
58500	3956208000	36	36	44	54	54	160	0.098	55
58500	3956108000	49	49	68	70	70	200	0.098	65