

SCHWINGMETALL® Compression Mounts

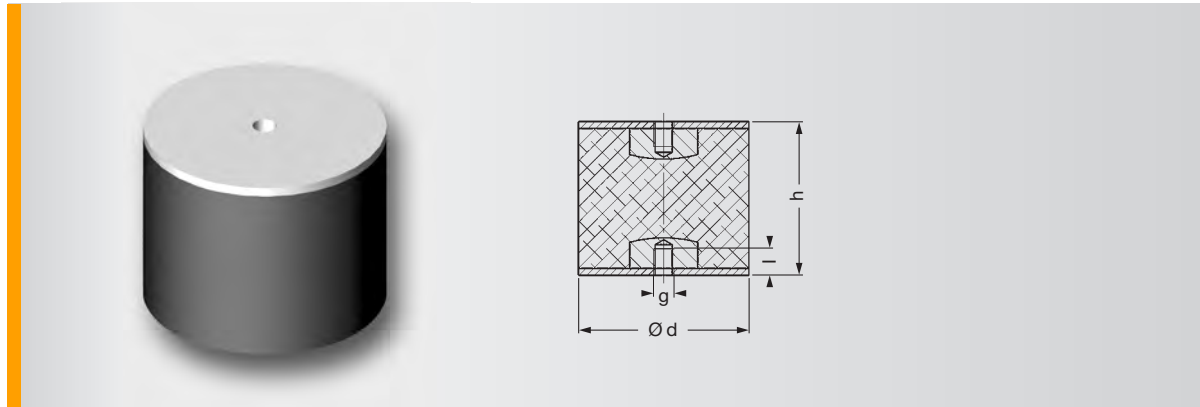

Compression Mounts C Type 21887/C - 31660/C

Mould No.	Part No.	Dimensions				Spring Stiffness			Max. Loads			Mass Piece [kg]	Elastomer Hardness [Shore A]
		d [mm]	h [mm]	l [mm]	g	C _x [N/mm]	C _y [N/mm]	C _z [N/mm]	F _x [N]	F _y [N]	F _z [N]		
21887/C	3913402000	13	26	5.0	M4	2	2	13	25	25	65	0.009	40
21887/C	3913202000	13	26	5.0	M4	3	3	25	27	27	80	0.009	55
21887/C	3913102000	13	26	5.0	M4	4	4	40	29	29	110	0.009	65
25326/C	3913404000	15	15	4.5	M4	13	13	68	35	35	90	0.007	40
25326/C	3913204000	15	15	4.5	M4	24	24	125	40	40	125	0.007	55
25326/C	3913104000	15	15	4.5	M4	37	37	190	43	43	160	0.007	65
31658/C	3913406000	20	25	6.0	M6	8	8	39	60	60	150	0.020	40
31658/C	3913206000	20	25	6.0	M6	14	14	73	65	65	180	0.020	55
31658/C	3913106000	20	25	6.0	M6	22	22	114	70	70	225	0.020	65
25356/C	3913412000	30	20	7.0	M8	30	30	230	150	150	400	0.042	40
25356/C	3913212000	30	20	7.0	M8	56	56	410	160	160	500	0.042	55
25356/C	3913112000	30	20	7.0	M8	87	87	626	170	170	650	0.042	65
31660/C	3913413000	30	30	7.0	M8	13	13	74	150	150	350	0.051	40
31660/C	3913213000	30	30	7.0	M8	24	24	139	160	160	420	0.051	55
31660/C	3913113000	30	30	7.0	M8	37	37	217	170	170	600	0.051	65