

MEGI® Machine Mounts

Megi Machine Mounts
Part No. 786 013
Versions:
hard, medium, soft

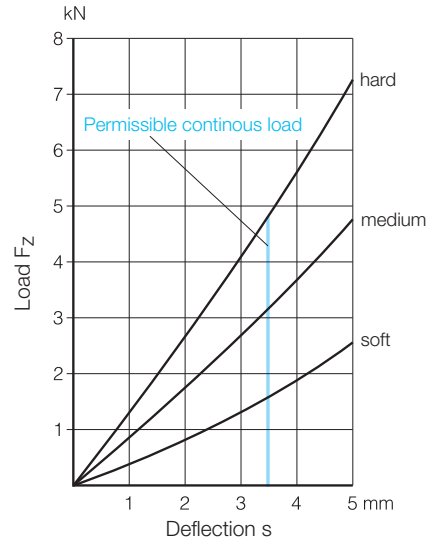

Megi Machine Mounts with height adjustment
Part No. 786 113
Versions:
hard, medium, soft

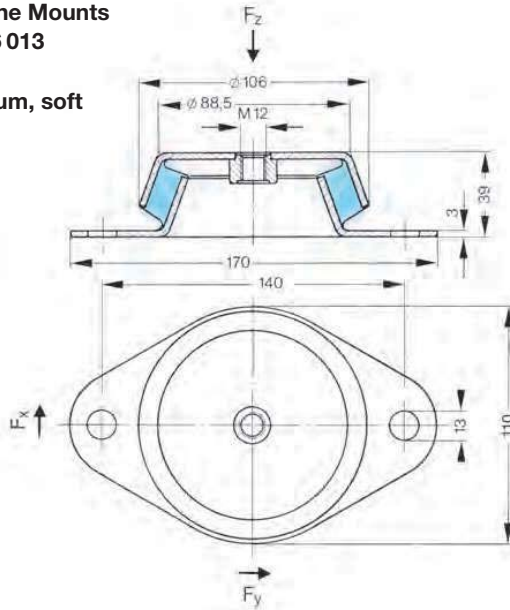
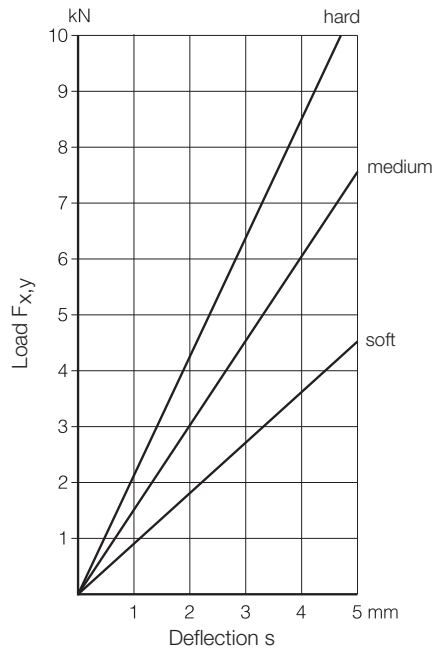
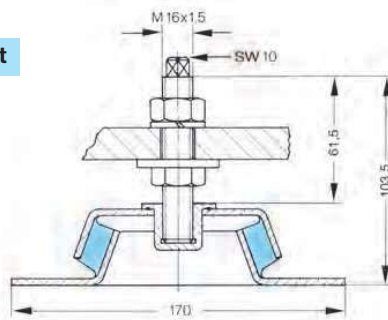

Megi Machine Mounts with tear-off protection
Part No. 786 213
Versions:
hard, medium, soft

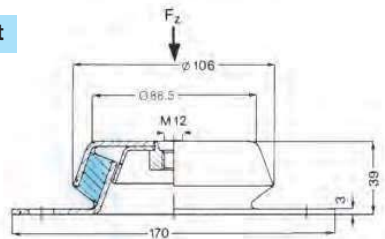

Other dimensions and materials are available on request