

Product information

Cross sectionview

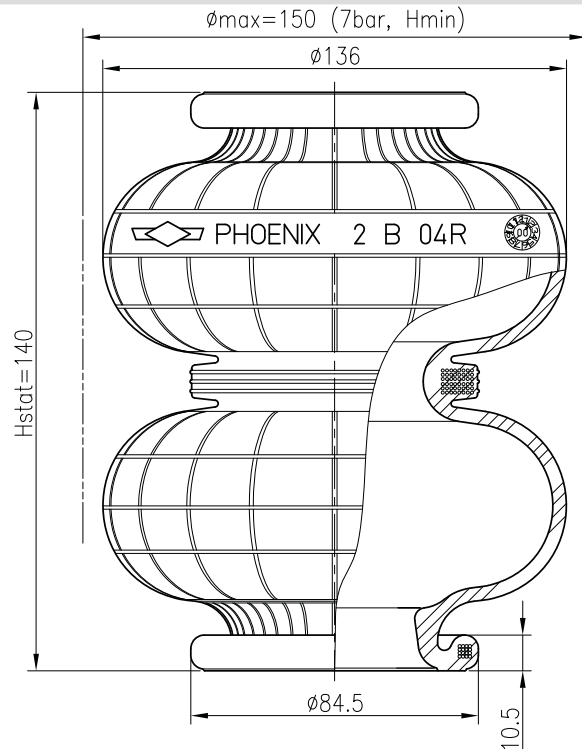

Bead ring

Bead ring are not included.

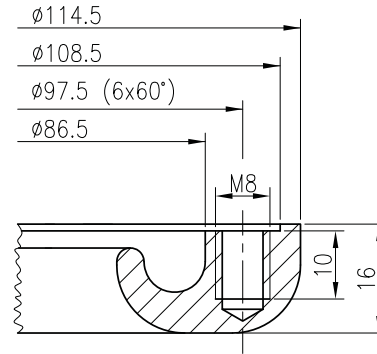

Technical data

Loading capacity max. (7 bar)	5.4 kN
Max. lifting pressure	8.0 bar
Diameter max.	150 mm
Required space \emptyset	175 mm
Height max.	190 mm
Height min.	80 mm
Weight	0.47 kg
Force to collapse to min. height	

DYNAMIC DATA

Static height 140 mm

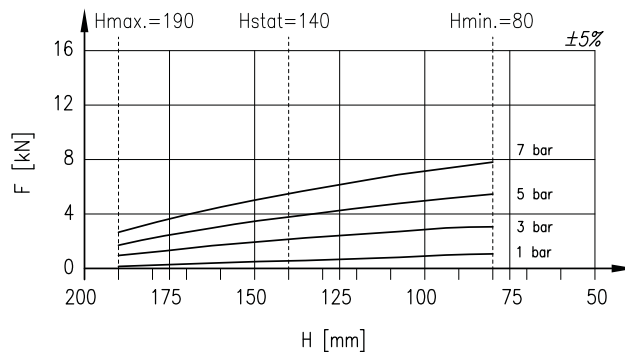

PRESSURE bar	FORCE kN	SPRING RATE N/cm	NATURAL FREQU. Hz
1	0.6	234	3.22
3	2.3	485	2.29
5	4.0	757	2.15
7	5.4	1029	2.17