

## Product information

## Cross sectionview

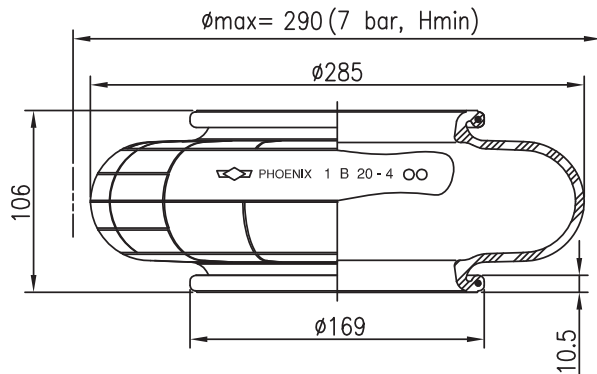

## Bead ring

Bead ring are not included.

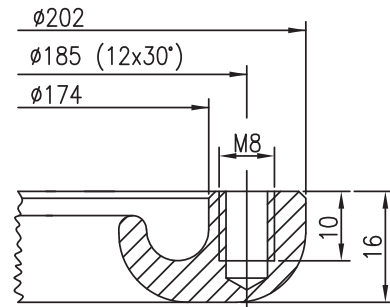

## Technical data

Loading capacity max. (7 bar)	23.40 kN
Max. lifting pressure	8.0 bar
Diameter max.	290 mm
Required space $\varnothing$	320 mm
Height max.	175 mm
Height min.	55 mm
Weight	1.08 kg
Force to collapse to min. height	

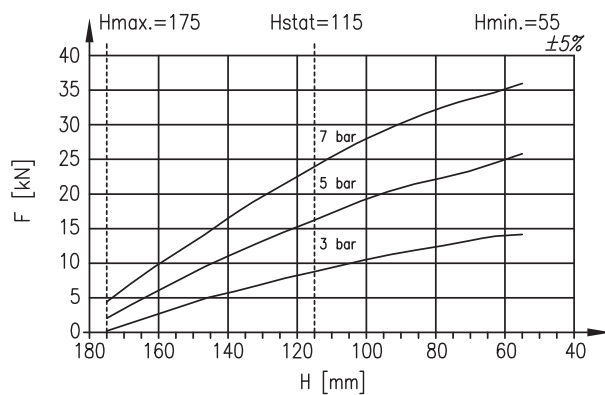

## DYNAMIC DATA

Static height 115 mm

PRESSURE bar	FORCE kN	SPRING RATE N/cm	NATURAL FREQU. Hz
1	2.4	995	3.17
3	9.0	2475	2.61
5	15.8	3949	2.48
7	23.4	5456	2.40