

EH Machine Mount with tear-off protection

786243

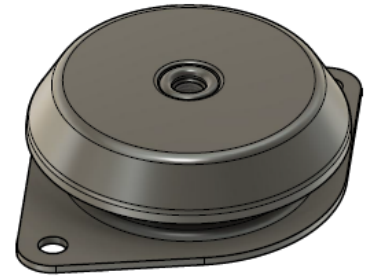

- ✓ Max. load F_z 800 N
- ✓ Spring stiffness 180 N/mm

Installation Dimensions

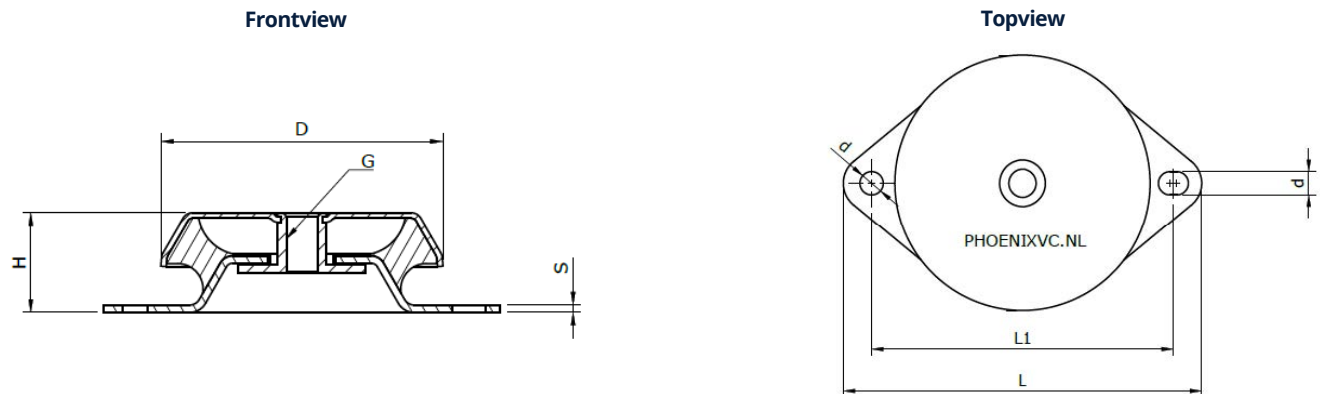

Technical Specifications

Type	Dimensions							Max. tightening torque
	D (mm)	L1 (mm)	L (mm)	H (mm)	d (mm)	s (mm)	G (mm)	Nm
786243	84	110	135	35,5	11	2,5	M12	70

Spring Stiffness (N/mm)	Max. Load (N)
$C_z \pm 20\%$	F_z
180	800

Static Stiffness and Natural Frequency Curves

