

Product information

Cross sectionview

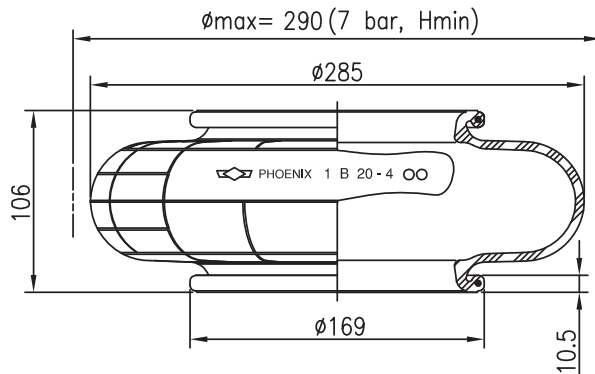

Bead ring

Bead ring are not included.

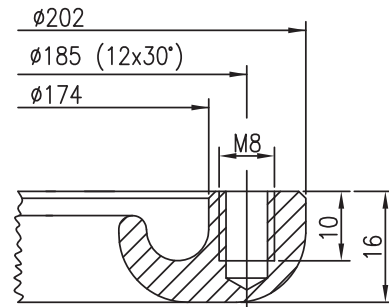

Technical data

Loading capacity max. (7 bar)	23.40 kN
Max. lifting pressure	8.0 bar
Diameter max.	290 mm
Required space Ø	320 mm
Height max.	175 mm
Height min.	55 mm
Weight	1.08 kg
Force to collapse to min. height	

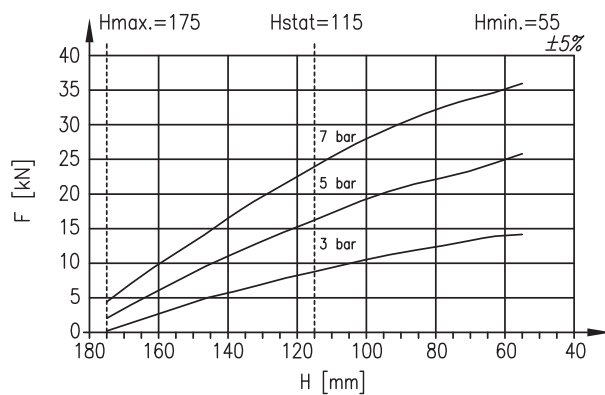

DYNAMIC DATA

Static height 115 mm

PRESSURE bar	FORCE kN	SPRING RATE N/cm	NATURAL FREQU. Hz
1	2.4	995	3.17
3	9.0	2475	2.61
5	15.8	3949	2.48
7	23.4	5456	2.40