

Product information

Cross sectionview

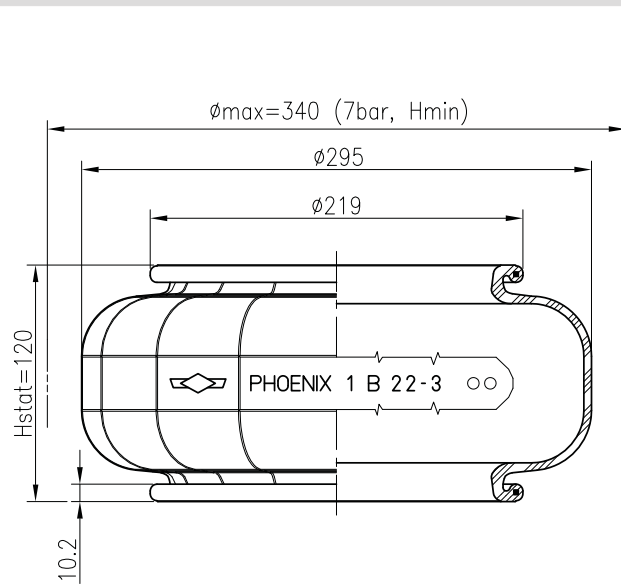

Bead ring

Bead ring are not included.

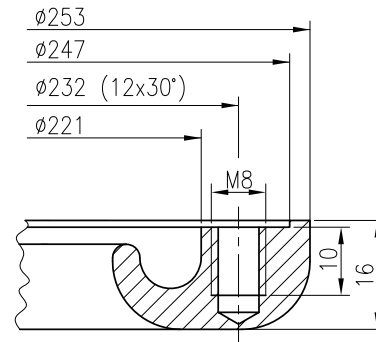

Technical data

Loading capacity max. (7 bar)	29.60 kN
Max. lifting pressure	8.0 bar
Diameter max.	340 mm
Required space \emptyset	380 mm
Height max.	180 mm
Height min.	60 mm
Weight	1.30 kg

Force to collapse to min. height

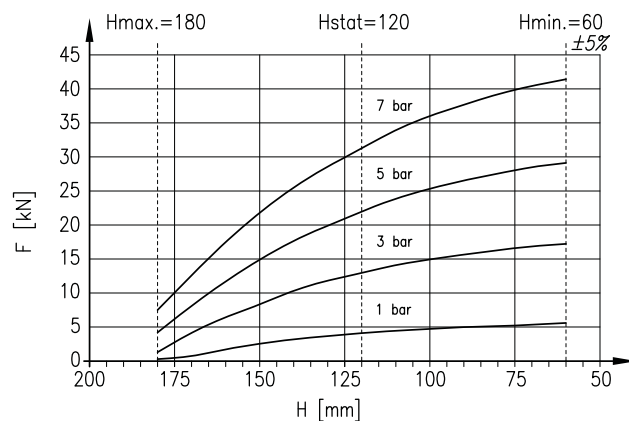

DYNAMIC DATA

Static height 120 mm

PRESSURE bar	FORCE kN	SPRING RATE N/cm	NATURAL FREQU. Hz
1	4.2	1654	3.06
3	12.0	3202	2.55
5	20.2	4952	2.44
7	29.6	6648	2.33